

**Montageanleitung**  
**Arbeitsscheinwerfer**

**Mounting Instructions**  
**Work lamps**

**Instructions de montage**  
**Projecteur de travail**

**Monteringsanvisning**  
**Arbetsstrålkastare**

**Montagehandleiding**  
**Werklamp**

**Instrucciones de montaje**  
**Faro de trabajo**

**Istruzioni di montaggio**  
**Faro de lavoro**

**Asennusohje**  
**Työvaloneheitintä**



**AS300**  
**AS400**  
**AS500**



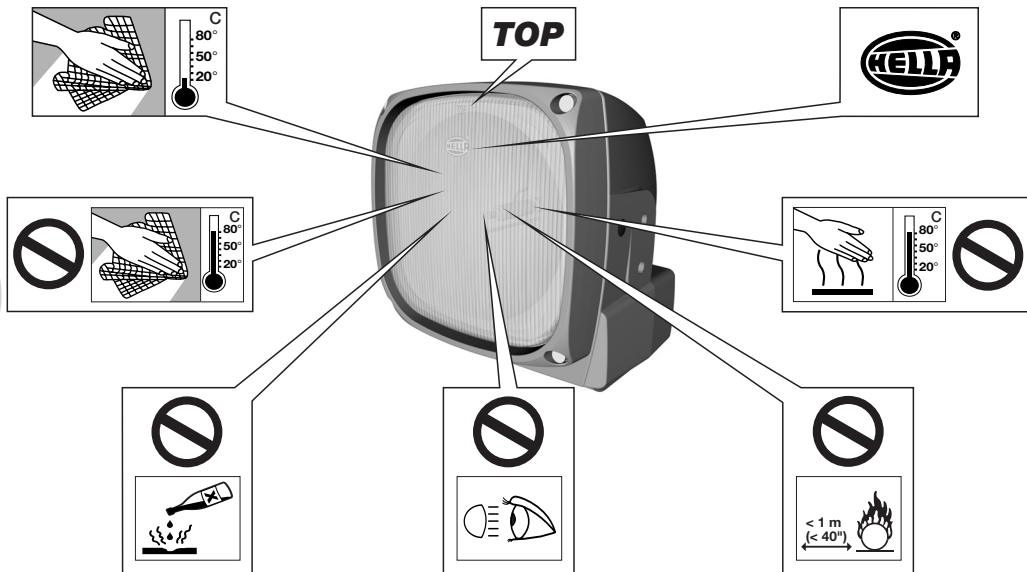

## Produkthaftung

- Es sind die nationalen Anbau-, Einbau- und Betriebsvorschriften zu beachten und einzuhalten.
- Lesen Sie bitte vor Gebrauch des Gerätes alle beigelegten Anleitungen und Sicherheitshinweise.
- Im Zuge von Produktverbesserung behalten wir uns technische und optische Änderungen vor.
- Verwenden Sie nur die Originalersatzteile bzw. nur Ersatzteile die von HELLA freigegeben sind.
- Bei Fragen oder Einbauproblemen, rufen Sie den HELLA Kundendienst, Großhändler oder wenden Sie sich an Ihre Vertragswerkstatt.

## Product liability

- National mounting, fitting and operating regulations must be heeded and kept.
- Please read all the instructions and safety notes included before using the device.
- We reserve the right to make technical and optical modifications within the course of product improvement.
- Only use original spare parts or spare parts approved by HELLA.
- If you have any questions or installation problems, call HELLA customer services, your wholesaler or contact your specialist garage.

## Responsabilité produit

- Les prescriptions nationales en matière de montage et de service doivent être observées et respectées.
- Avant d'utiliser l'appareil lire toutes les instructions de montage et de service fournies ainsi que les conseils de sécurité.
- Dans le cadre de l'amélioration continue de nos produits, nous nous réservons le droit de réaliser des modifications sur les plans technique et optique.
- Utilisez uniquement des pièces d'origine ou des pièces de rechange validées par HELLA.
- Pour tous renseignements ou problèmes de montage, contactez le S.A.V. HELLA, votre distributeur ou votre garage lié par contrat.

## Produktansvar

- De nationella monterings-, installations- och driftföreskrifterna ska beaktas och följas.
- Läs alla medföljande instruktioner och säkerhetsanvisningar innan du använder apparaten.
- Vi förbehåller oss rätten till tekniska och optiska ändringar som förbättrar produkten.
- Använd endast original reservdelar resp. endast reservdelar som har godkänts av HELLA.
- Om du har frågor eller problem med installationen, ring HELLA kundtjänst, parthandlaren eller vänd dig till din märkesverkstad.

## Productaansprakelijkheid

- Men dient de nationale aanbouw-, inbouw- en bedrijfsvoorschriften in acht te nemen en na te leven.
- Lees a.u.b. alvorens het apparaat te gebruiken alle bijgevoegde gebruiksaanwijzingen en veiligheidsinstructies door.
- In het kader van de productverbetering behouden wij ons technische en optische veranderingen voor.
- Gebruik uitsluitend de originele reserveonderdelen, die door Hella vrijgegeven zijn.
- Bij vragen of inbouwproblemen dient u de HELLA klantenservice, de groothandel te bellen of u te richten tot de dealerwerkplaats.

## Responsabilidad civil por productos defectuosos

- Tienen que observarse y cumplirse con las prescripciones nacionales sobre construcciones anexas, de montaje y de funcionamiento
- Rogamos que antes de usar el aparato lean todas las instrucciones y advertencias sobre la seguridad adjuntas.
- En aras de la mejora de los productos, nos reservamos el derecho de hacer modificaciones técnicas y ópticas.
- Use sólo recambios originales o bien sólo recambios autorizados por HELLA.
- Si tiene preguntas que hacernos o dificultades en el montaje, llame al Servicio de Atención al Cliente de HELLA, a los mayoristas o dirijase a su taller concesionario.

## Responsabilità per il prodotto

- si devono rispettare tutte le normative nazionali di attacco, montaggio e funzionamento.
- Prima di usare l'apparecchio, legga per favore tutte le istruzioni e le avvertenze di sicurezza allegate.
- Nell'ambito del perfezionamento del prodotto, ci riserviamo modifiche tecniche ed estetiche.
- Utilizzare solo pezzi di ricambio originali risp. pezzi autorizzati dalla HELLA.
- In caso di domande o problemi di montaggio, chiami il servizio di assistenza dei clienti della HELLA, il rivenditore o si rivolga alla Sua officina autorizzata.

## Tuotevastuu

- Kansalliset asennus- ja käyttöohjeet on huomioitava ja niitä on noudatettava.
- Lue ennen laitteen käyttöä kaikki oheistetut käyttö- sekä turvaohjeet.
- Jatkuvasta tuotekehittelystä johtuen pidätämme oikeuden teknisiin ja optisiin muutoksiin.
- Käytä vain alkuperäisiä tai HELLAN hyväksymiä varaosia.
- Jos Sinulla on kysymyksiä tai asennusongelmia, soita HELLA-asiakaspalveluun, tukkukauppiaalle tai käänny sopimuskorjaamon puoleen.

Anbauscheinwerfer öffnen  
Öppna den utvändiga strålkastaren  
Aprire proiettore da attaccare

Open surface-mounted worklamp  
Opbouwschijnwerpers openen  
Päälle asetettavan valonheittimen avaaminen

Ouvrir le projecteur pour montage appliqué

## AS300 / 400 / 500



4

AS 400  
AS 500

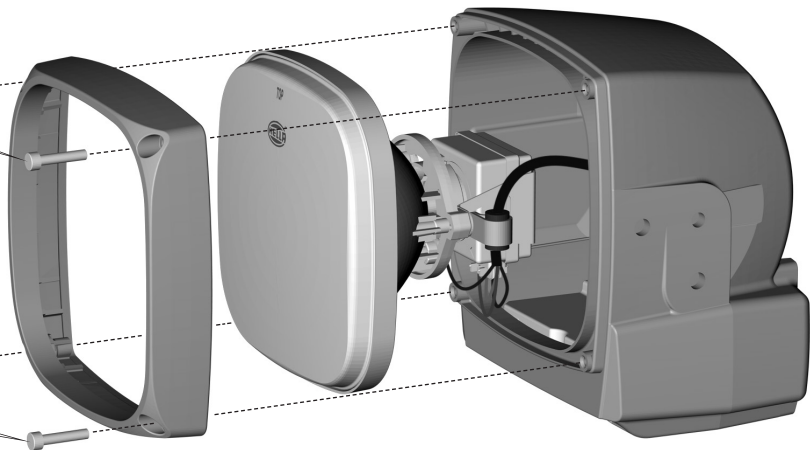



**H3**

12V/35W: 8GH 002 090-271

12V/55W: 8GH 002 090-131

24V/70W: 8GH 002 090-251

5

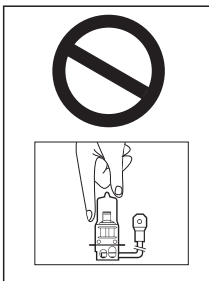
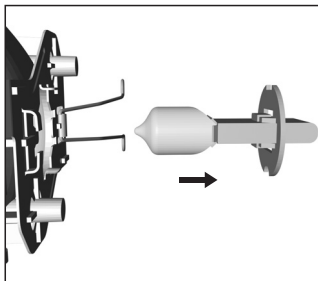
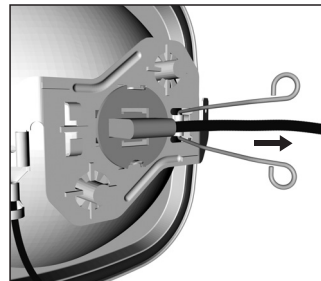
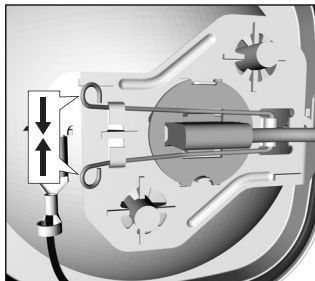
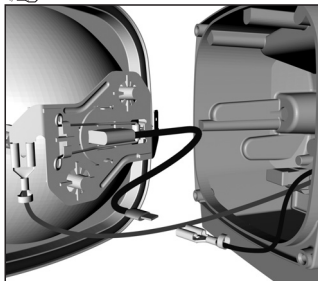

6

 **D1S 35W**

Hella 8GS 990.332-001

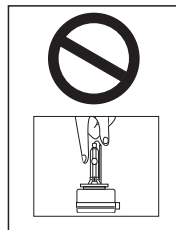
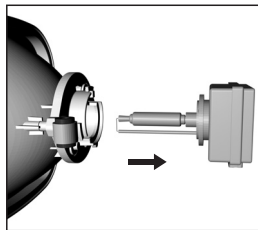
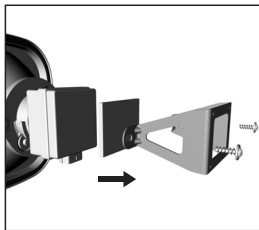
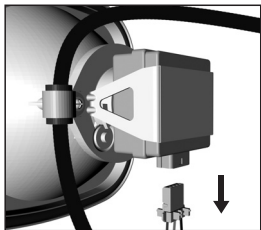

 **D2S 35W**

Hella 8GS 007.949-101

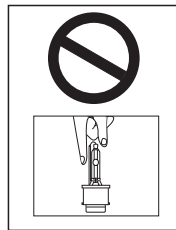
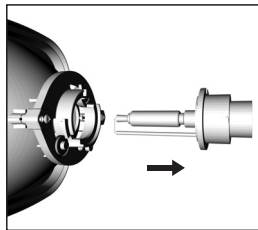
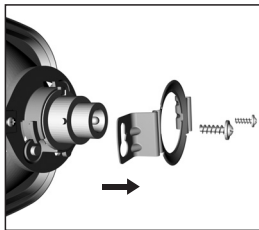
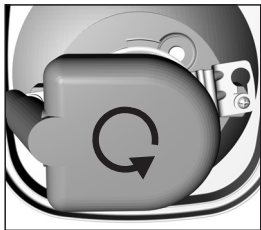

Montage AGRO Bügel  
Byt ut AGRO bygeln  
Sostituire la staffa AGRO

Replace AGRO hoop  
AGRO beugel vervangen  
AGRO isangan vaihto

Remplacer l'étrier AGRO  
Reemplazar el estribo AGRO

7

AS300

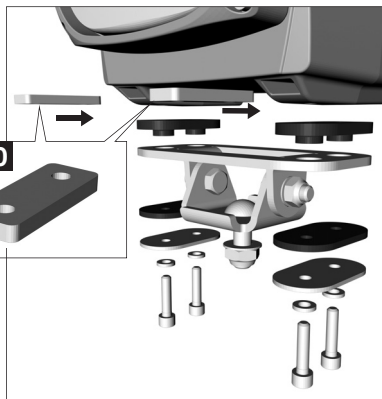

TOP



Ø10,2 mm

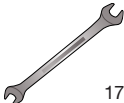

17 mm

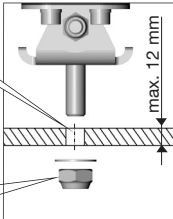

- DE** Die hängende Montage ist nur für Scheinwerfer mit H3 oder D2S möglich - durch Drehen der Reflektorgruppe um 180 Grad.
- EN** Suspended installation is possible for headlamps with H3 or D2S only - by turning the reflector assy by 180 degrees.
- FR** Uniquement les projecteurs H3 ou D2S sont adaptés au montage suspendu, en tournant l'ensemble de réflecteurs de 180 degrés.
- SV** Hängande montering är möjlig endast för strålkastare med H3 eller D2S - genom att vrida reflektorgruppen 180 grader.
- NL** De hangende montage is alleen mogelijk voor schijnwerpers met H3 of D2S - door het draaien van de reflectorgroep met 180 graden.
- ES** El montaje colgando sólo es posible para faros H3 o D2S - girando el grupo de reflectores en 180 grados.
- IT** Il montaggio sospeso è possibile solo per fari con H3 o D2S - ruotando di 180 gradi il gruppo dei riflettori.
- FI** Riippuva asennus on mahdollista vain H3- tai D2S-polttimoilla varustetuissa valonheittimissä - kääntämällä heijastajaryhmää 180 astetta.



Montage heavy-duty Bügel  
Byt ut heavy-duty bygeln  
Sostituire la staffa „heavy-duty“

Replace heavy-duty hoop  
Heavy-duty beugel vervangen  
Heavy-duty-sangan vaihto

Remplacer l'étrier « Heavy Duty »  
Remplazar el estribo « Heavy Duty »

9

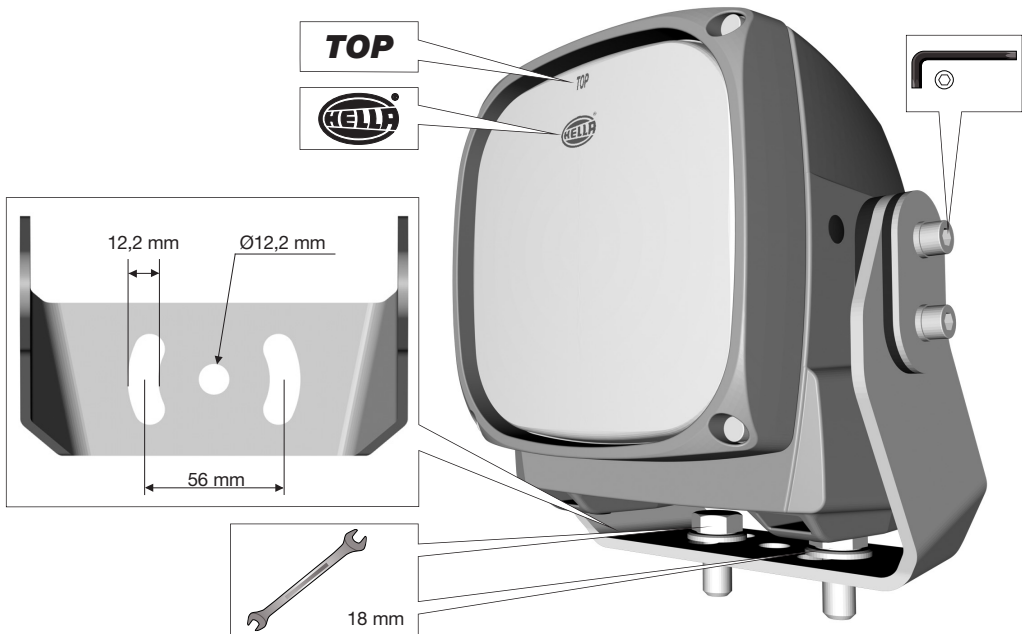

Montage „Heavy.Duty“ Bügel  
Byt ut „Heavy.Duty“ bygeln  
Sostituire la staffa „Heavy.Duty“

Replace „Heavy.Duty“ hoop  
„Heavy.Duty“ beugel vervangen  
„Heavy.Duty“-sangan vaihto

Remplacer l'étrier « Heavy.Duty »  
Remplazar el estribo « Heavy.Duty »

10

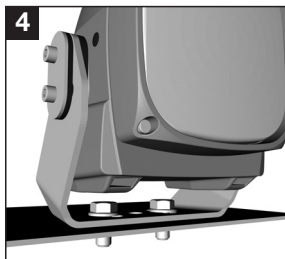
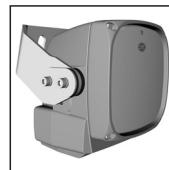
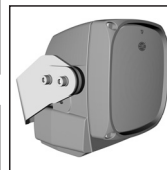
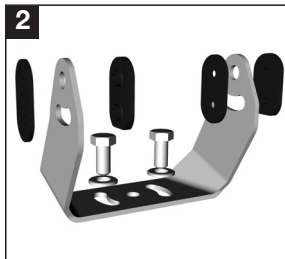
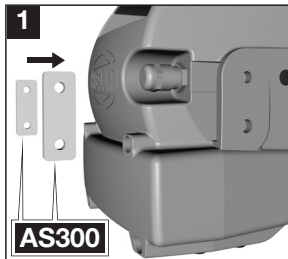

Direkte Montage ohne Bügel  
Direktmontering utan krampa  
Montaggio diretto senza staffa

Direct mouning without bracket  
Directe montage zonder beugel  
Suora asennus ilman sankaa

Montage direct sans étrier  
Montaje directo sin estribo

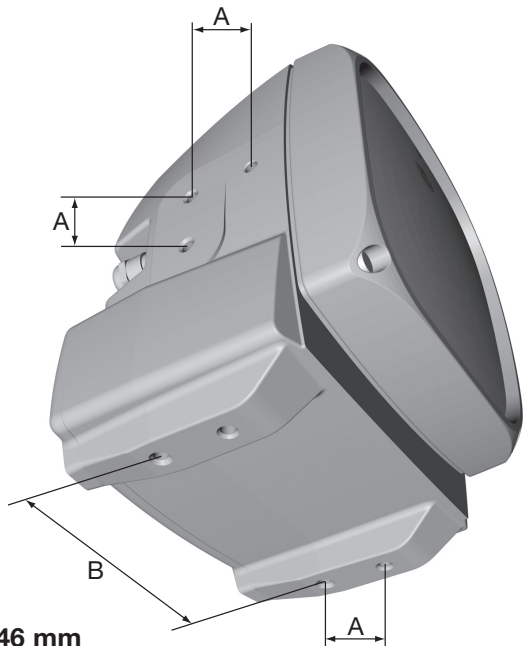
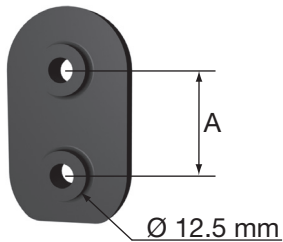

**A = 25 mm    B = 100 mm    C = 146 mm**

Vorschaltgerät tauschen  
Byt ut det integrerade förkopplingsdonet  
Sostituire ballast integrato

Exchange integrated ballast  
Geïntegreerd voorschakelapparaat vervangen  
Integroidun muunninyksikön vaihto

Echanger le ballast intégré  
Cambiar el aparato de preconexión integrado

**D1S**

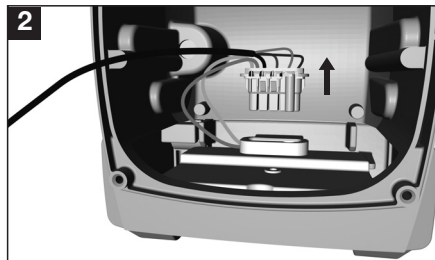
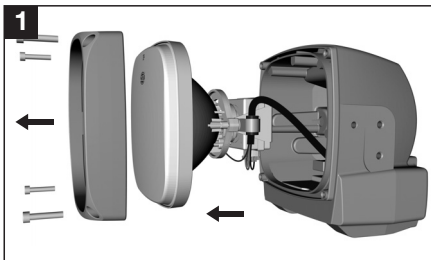

12

AS 400  
AS 500



AS 300

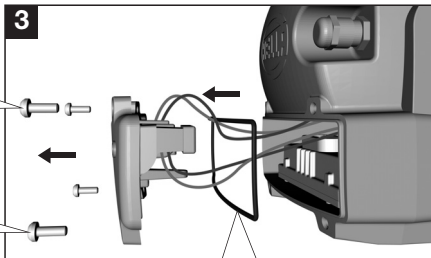

Siehe Seite 14  
See page 14  
Cf. page 14  
Se sidan 14

Zie pagina 14  
Véase página 14  
Vedere pagina 14  
Katso sivu 14

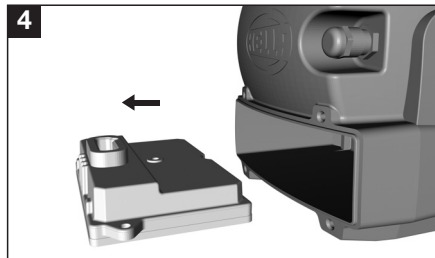

Vorschaltgerät tauschen  
Byt ut det integrerade förkopplingsdonet  
Sostituire ballast integrato

Exchange integrated ballast  
Geïntegreerd voorschakelapparaat vervangen  
Integroidun muunninyksikön vaihto

Echanger le ballast intégré  
Cambiar el aparato de preconexión integrado

**D2S**

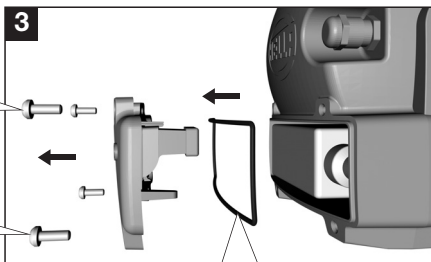
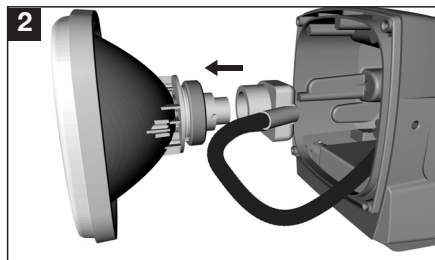
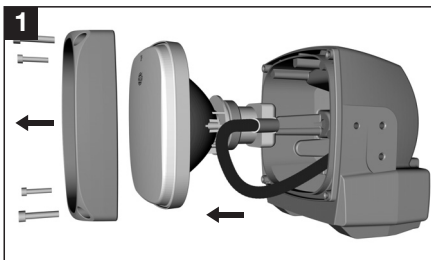

AS 400  
AS 500



AS 300



Siehe Seite 14  
See page 14  
Cf. page 14  
Se sidan 14

Zie pagina 14  
Véase página 14  
Vedere pagina 14  
Katso sivu 14

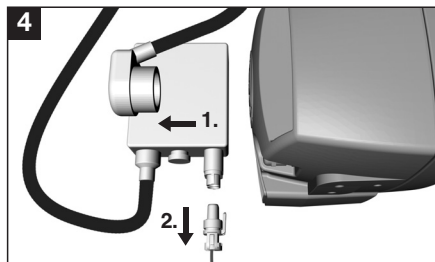

- Dichtung:** Beim Verschliessen des Scheinwerfers ist auf das ordnungsgemässe Einlegen des O-Rings zu achten - siehe Seite 12 / Abb. 3.
- DE** **Filter:** Der Filter ist nur bei Sonderausführungen enthalten - siehe Seite 13 / Abb. 3.
- EN** **Seal:** Ensure correct insertion of the O-ring when closing the headlamp - see page 12 / fig. 3.
- EN** **Filter:** The filter is included in special variants only - see page 13 / fig. 3.
- FR** **Joint:** Lors de la fermeture du projecteur veillez à la bonne mise en place du joint torique - cf. page 12 / fig. 3.
- FR** **Filtre:** Le filtre n'est livré que pour les réalisations spécifiques - cf. page 13 / fig. 3.
- SV** **Packning:** Kontrollera när strålkastaren monteras att O-ringens sätts i rätt - se sidan 12/bild 3.
- SV** **Filter:** Filtret ingår endast i specialvarianter - se sidan 13/bild 3.
- NL** **Dichting:** Bij het afsluiten van de schijnwerper dient op het correcte aanbrengen van de O-ring te worden gelet - zie pagina 12 / afb. 3.
- NL** **Filter:** Het filter is uitsluitend bij speciale uitvoeringen aanwezig - zie pagina 13 / afb. 3.
- ES** **Junta:** Al cerrar el faro es necesario prestar atención en colocar correctamente el anillo de junta toroidal - véase página 12 / fig. 3.
- ES** **Filtro:** El filtro sólo va dispuesto en versiones especiales - véase página 13 / fig. 3.
- IT** **Guarnizione:** quando si chiude il faro fare attenzione ad inserire regolarmente la guarnizione circolare - vedere pagina 12 / fig. 3.
- IT** **Filtro:** il filtro è compreso solo nelle versioni speciali - vedere pagina 13 / fig. 3.
- FI** **Tiiviste:** Valonheittä suljettaessa on huomioitava, että O-rengas sijoitetaan paikoilleen oikein - katso sivu 12 / kuva 3.
- FI** **Suodatin:** Suodatin on vain erikoismalleissa -katso sivu 13 / kuva 3.

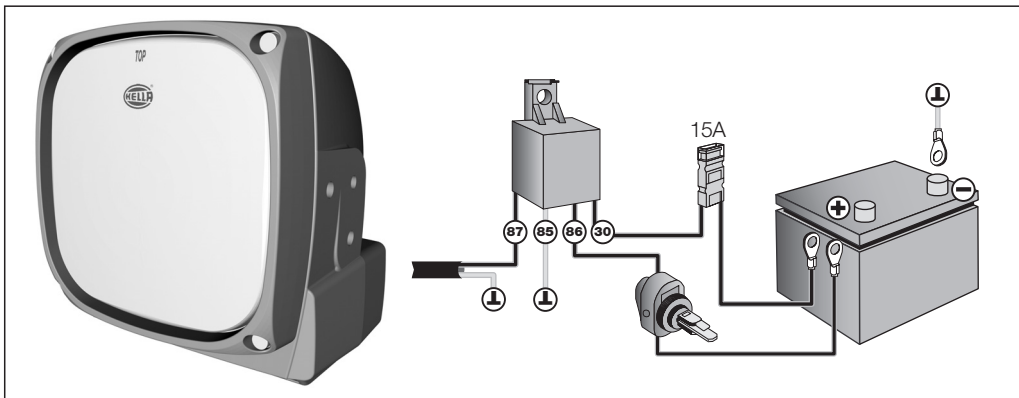

**Hella Fahrzeugteile Austria GmbH**

Target Group Agricultural, Construction and Utility Machinery

Target Group Power Sports

A-1100 Wien / Vienna Austria

460 879-10 11/07

